

Contents

Preface	4
Disclaimer	5
Frequently used terms	6
Guidelines for data transfers	7
The data model	12
1. Root	12
2. Key fields	13
3. WOK_Operator	14
4. Correction (Ksa_Cancellation)	16
5. WOK_Player_Profile	19
6. WOK_Player_Flags	25
7. WOK_Player_Account_Transaction	27
8. WWFT_Player_Account_Transaction	31
9. WOK_Player_Limits	35
10. WOK_Intervention	43
11. WOK_Game	46
12. WOK_Game_Session	50
13. WOK_Bet	54
14. WOK_Complaint	62
15. Custom data types used in the data formats	66

Errata and changes to previous versions

Previous versions of the data model

Previous versions of the data model are:

- Version 1.00 authorized for public release 17 November 2020
- Version 1.01 authorized for public release 10 February 2021

Errata and changes

Changes to version 1.01 are marked in this version to facilitate quick identification. It remains the operator's responsibility to comply with this version of the data model.

These changes have been marked in orange. Please note that the XSDs are always leading (as indicated in the specifications CDB).

Preface

The [revision of the Dutch Gambling Act](#), passed by Dutch Senate on February 20, 2019, stipulates the use of a data-based control system (Controle Data Bank, the CDB). Purpose of this system is a secure exchange of regulatory data between licensed operators and Dutch regulators.

The Netherlands Gambling Authority (Kansspelautoriteit, Ksa) describes its requirements regarding the CDB in two documents:

- The 'technical requirements' document contains requirements of a technical, organisational and procedural nature, and
- The 'data model' document details content and processing of regulatory data.

Both shall be used by operators when designing, operating or discontinuing the aforementioned CDB, when they apply for or already obtained a remote gambling licence under Dutch regulations.

In addition to the documents Ksa may separately provide:

- practical information like explanations, updates and schemas
- specific technical information that is likely to vary over time (like IP-addresses, encryption materials)

A review of the two documents is expected after approximately 6-12 months. This will be done in order to accommodate initial use phase feedback and further European level harmonisation concerning data reporting for remote gambling.

When review takes place this will be communicated through the Ksa website.

The Dutch Tax Authority has independent access to the CDB. It uses the CDB for different regulatory purposes and has the right to inspect its own (limited) data set. The Tax Authority uses its own means to access the CDB and has its own data model, access frequency and the like.

Tax Authority requirements with regard to the CDB are therefore published separately.

The licensee has an obligation to implement the CDB in accordance with the requirements set out below.

Disclaimer

No independent permission can be derived from these requirements -or any additional information provided by Ksa regarding these requirements- for offering a particular game of chance or part thereof. Permission to offer a certain game of chance exists only and to the extent that the operator has been granted a licence for offering a game of chance as referred to in the Dutch Gambling Act.

Operators shall comply with all requirements, including updates and additions. Noncompliance with these requirements is considered a violation of Dutch regulation and may lead to corrective measures by Ksa.

Under all circumstances the text of the Dutch Gambling Act -including regulations based on that Act- prevails. An operator must contact Ksa whenever there is unclarity or ambiguity about the way a certain requirement can be interpreted.

Frequently used terms

Data safe or Controle Data Bank (CDB)

The data safe is a secure storage location for data files that is accessible to the regulator. The data safe is made available and maintained by the operator. A single operator may have multiple data safes.

Record

Technically, any XML node may be considered a data record. In the context of this document however, a record is a single XML node, that may have zero or more subnodes but has no parent nodes other than <root>.

Regulator

The regulator in this document is The Netherlands Gambling Authority.

Currency

In the CDB there is only one type of currency: EURO. The operator must convert all other currency such as but not limited to Pound Sterling, Dollars, in game Coins, diamonds or in kind winnings, to the equal value in Euro's.

Time Zone

All timestamps in the database are always in Coordinated Universal Time (UTC)

Real Time / Near Real Time

The gambling regulation requires that data is transferred into the CDB final data repository real time or near real time. To assist operators with this transfer, the frequency of extraction and the trigger for reporting the information is noted in the description of the record. Unless otherwise specified:

- source extraction of the data must take place immediately after the original registration in that source;
- placement of the data into the CDB final data repository must take place within 30 minutes after the extraction.

Guidelines for data transfers

The usage of an WWFT safe has been discontinued on 25th April 2023 09:34 hours UTC.

This chapter describes the way in which data files must be stored in the data safe.

FILE FORMAT AND SIZE

Data must be stored in XML. XML files must be compliant with the XSD schemas published on the regulator's website. An XML file must be in UTF 8 and must contain at least one record. A record, in the context of this document, is an XML element which has no parents other than the mandatory <root> element which must be the root element for each XML file. Each XML file must be stored batch wise in a batch data file when it reaches a maximum of 512 records or when the batch data file is closed. Records must be sent into a single XML file as much as possible. E.g. when there are 515 records in the batch, we expect an XML file with 512 records and a second XML file with 3 records.

Added for clarification

The XML file should be named according to the following format:

[XSD_name]-[N]-[yyyymmddhhmmss_start].xml

in which

- XSD_name is the filename of the XSD used to create the xml;
 - Example: WOK_bet_v1.o.xsd => XSD_name is **WOK_bet_v1.o**;
- N is a sequential counter of the XML, with leading zeros, 10 digits, to be reset at the beginning of a new day;
 - Example: the first XML of the day => counter value is **0000000001**
- yyyymmddhhmmss_start is the timestamp for the moment the file was created.
 - Example: a file is created on the 1st of January 2022 at 13:24:25 hours CET => timestamp is **20220101132425**

Examples are added for clarification

The combination of the above examples results in the file:

WOK_bet_v1.o-0000000001-20220101132425.xml

Batching

The XML's are stored batchwise in a batch data file.

The batch data file should be named according to the following format:

[operator_id]-[data_safe_id]-[N]-[yyyymmddhhmmss_start].zip

in which

- operator_id is the unique number granted by the regulator. This number will be communicated during the test phase;
 - Example: an operator has the ID Ksa.007 assigned => operator_id is **Ksa.007**

- data_safe_id is the id of the data safe, provided by the operator. Data_Safe_ID is unique and incremental.

Examples are added
for clarification

- N is a sequential counter of the Batch, 10 digits, with leading zeros; (exhaustion of this counter is not expected before the release of a new data model)
 - Example: the very first batch => counter value is **000000001**;
- yyyyymmddhhmmss_start is the timestamp for the moment the file was created.
 - Example: a file is created on the 1st of January 2022 at 13:24:25 hours CET => timestamp is **20220101132425**

The combination of the above examples results in the WOK-file:

- **Ksa.007-3-000000001-20220101132425.zip**
- Or **Ksa.007-1_2-000000001-20220101132425.zip**

A batch data file is closed when one of the following instances occurs:

- after a maximum interval of 5 minutes;
- as soon as the received data volume (in compressed form) has reached 100 MB;
- at 00:00 (UTC) every day.

Before a batch data file is added to the final data repository, it must be processed as described below.

FILE PROCESSING

Before a batch data file is added to the final data repository, it must be processed. The following steps must be taken:

□ *Control Manifest XML*

The control manifest XML is created. The name of the manifest XML consists of the name of the batch data file preceded by the name of the control manifest XSD. A XSD schema for the control manifest file will be made available by the regulator (i.e. on its website).

□ *Compression*

The batch data file must be compressed to a .zip file using the Deflate algorithm (RFC1951).

□ *Encryption*

The compressed file must be encrypted using the AES-256 algorithm. The compressed data is encrypted with a symmetric AES-256 session key, dynamically generated by the operator. This session key is itself encrypted with RSA-2048, using the regulator's public key (X.509 certificate). The encrypted session key is stored in the control manifest XML.

□ *Renaming*

The encrypted compressed Batch data file must be renamed by adding **.enc** after the .zip extension.

□ *Hash_Value of Batch data file*

The hash value of the current encrypted batch data file must be added to the control manifest XML.

□ *Chaining*

The hash (SHA-256) of the previous 'Manifest_file' as placed in the data safe must be added to the current Manifest file. In case of the first Manifest file, a hash value of 0 (zero) shall be used for the absent previous Manifest file.

□ *Referencing*

References to the locations of files are added to the control manifest XML:

- Absolute path in URL syntax (without scheme and host) to the ZIP file.
The path corresponds with the folder structure;
- Absolute path in URL syntax (without scheme and host) to the previous ZIP file.
The path corresponds with the folder structure;

□ *Timestamp*

The Manifest file must be digitally signed using XAdES-T¹. The time for the timestamp must be delivered by any Timestamp Server compatible with the European eIDAS timestamps standard ETSI EN 319 422 (RFC 3161). The signature has to be included in the control manifest XML.

□ *Archiving*

The compressed encrypted batch data file and the control manifest xml must be included in a single .zip file. The .zip file must have the same name as the data file. Adding separate .zip files to the final data repository shall be done throughout the day.

DIRECTORY STRUCTURE

The files in the data safe shall be in folders that are named according to the following structure:

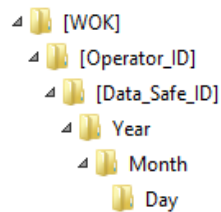

The usage of an WWFT safe has been discontinued on 25th April 2023 09:34 hours UTC.

Under normal circumstances (i.e. near real time delivery of data in the CDB), the year, month and day of the storage folder, refer to the moment the trigger for creation of a record took place. If a trigger is activated on day 1 but the record is actually created on day 2 (e.g. over midnight), the batch file containing the xmls shall be placed in the year, month and day folder of day 1.

Delayed delivery

Near real-time delivery of data must always take place. In the unlikely event that data is not made available near real time, this is a disruption to the operation of the CDB. In any circumstance data delivery shall not result in breaking or a disruption in chaining of files.

¹ <https://www.w3.org/TR/XAdES/>

Two different procedures for restoring delivery disruptions, shall be used:

1. Paused delivery

Near real-time delivery of data shall resume at the point where it has paused. Data shall be placed in the year, month and day folder of the moment the files should have been placed under normal circumstances. The data files (from moment of pause up to point of resumption of near real time delivery) shall be delivered in chronological order as specified under normal circumstances.

- Example: The entire data delivery is paused due to maintenance on 21 October. Data of 20 October is the last delivery placed in the CDB. On 23 October data delivery is resumed. At that moment, first the folder of 21 shall be filled, then the folder of 22 October shall be filled. Finally near real-time delivery of data referring to 23 October is resumed.

2. Delivery of missing data files

Data that should have been delivered, but is identified as missing, must be reported afterwards. In that case the missing data shall be delivered together with the regular near real time delivery of data. This implies that, the year, month and day of the storage folder, is dictated by the moment of placement in the current chain of near real-time delivery and not in the storage folder related to the year, month, day of the trigger. This is the only exception for placement of data in folders not related to the trigger.

This is a procedure for delivery of missing data files, not a correction method.

Corrections shall be handled as described in chapter 4: Correction.

- Example: On 15 November it turns out that one of the triggers malfunctions, which results in failure to generate a corresponding XML file. As a consequence, 1 hour of data from 14 November has not been placed in CDB. This hour of data shall be placed in folder of 15 November with the proper file name and chaining information as specified for near real-time delivery.

The data model

This chapter describes the way in which XML files must be created.

1. Root

Field name	Minimum	Maximum	Data type
Root	1	1	n/a

The root element has to be the outermost node of any XML file added to the data safe.

2. Key fields

The following fields will only be described in this paragraph but they need to be included in every record.

Field name	Minimum	Maximum	Data type
Record_ID	1	1	UID ²

The record ID needs to be unique across the entire data safe. It will be used in case the operator needs to make a correction.

Field name	Minimum	Maximum	Data type
Extraction_Date	1	1	dateTimeUTC ³

The extraction date is the date when the data was extracted from the operator's systems.

Field name	Minimum	Maximum	Data type
Operator_ID	1	1	stringMedium ⁴

Operator ID is the unique ID granted by the regulator. A legal entity which exploits different brands under a single license, needs to use the same ID in all data in its data safe(s).

Field name	Minimum	Maximum	Data type
Data_Safe_ID	1	1	stringMedium

Data safe ID is an unique ID for each data safe used by the operator, granted by the regulator.

² See [UID](#)

³ See [dateTimeUTC](#)

⁴ See [stringMedium](#)

3. WOK_Operator

What?	Description
Field name	WOK_Operator
Minimum	1
Maximum	1
Data type	n/a
Trigger	00:00 UTC time
Frequency	Once a day

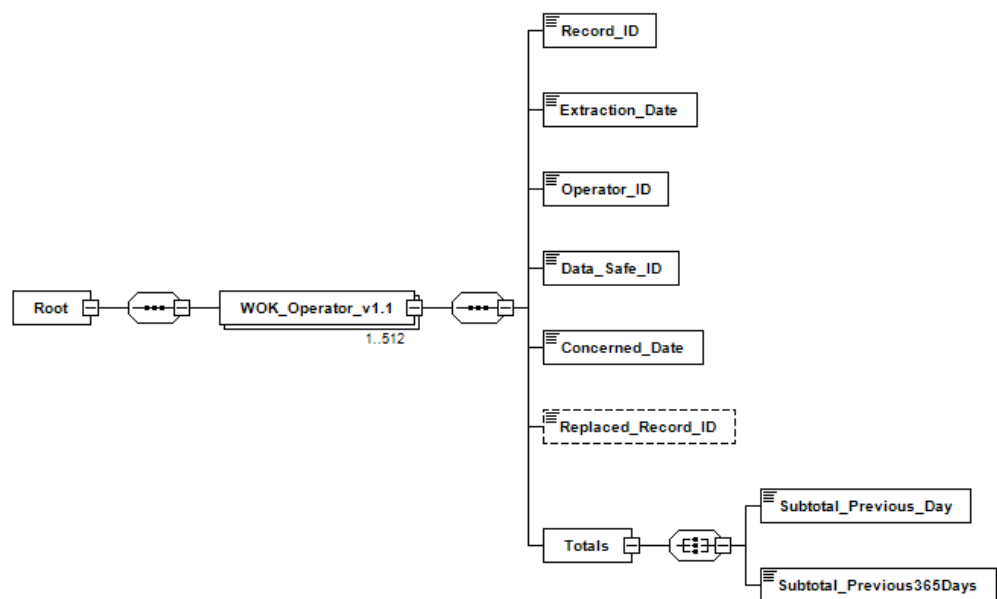

WOK_Operator represents the party that holds the remote gambling license.

Concerned_Date

Field name	Minimum	Maximum	Data type
Concerned_Date	1	1	date

The concerned date indicates the day that is being reported.

Totals

Field name	Minimum	Maximum	Data type
Totals	1	1	n/a

Totals is a parent element for totals. A legal entity which exploits different brands under a single license, must add the totals of its different brands together.

Subtotal_Previous_Day

Field name	Minimum	Maximum	Data type
Subtotal_Previous_Day	1	1	monetaryAmount ⁵

Subtotal previous day is the revenue of the day that is being reported. The subtotal of the previous day is the gross result, i.e. all customer stakes **plus commission** minus customer winnings. Taxes and operational costs must not be taken into consideration. This information is intended as an extra check on the consistency of the XML file. The correctness of this amount may also be verified via reports from other sources.

Subtotal_Previous365Days

Field name	Minimum	Maximum	Data type
Subtotal_Previous365Days	1	1	monetaryAmount ⁶

Subtotal previous 365 days is the subtotal of the previous 365 days (or in case of a leap year: **366 days for the period of a year to the 28th of February a year after**) plus the day that is currently being reported. The subtotal of the previous 265 days is the gross result, i.e. all customer stakes **plus commission** minus customer winnings. Taxes and operational costs must not be taken into consideration.

It is intended as an extra check on the consistency of the XML file. The correctness of this amount may also be verified via reports from other sources.

⁵ See [monetaryAmount](#)

⁶ See [monetaryAmount](#)

4. Correction (Ksa_Cancellation)

There are three ways of making a correction:

Correction method 1: send Delta

Correction method 2: send replacement

Correction method 3: send cancellation

General: No domino effect!

In case of a correction on a transaction that was originally reported on a previous day, the subtotals concerning that 'original' day may also be affected. However, it is not allowed to also send a corrected subtotal of that 'original' day. We do expect that the correction is incorporated in the subtotal _previous 365 days from the day of correction onwards.

Added for clarification

Sequence of the correction

In line with the CDB requirements, retention time is 12 months. In that time, all records must stay in the CDB, records shall not be deleted during the mandatory retention period. In case of a replacement, the previous record is 'invalidated' and will be disregarded during analyses by the Ksa. A cancellation of a record results in the 'inactivation' of that record and the entire chain of records, so including all previous records and possible replacements. A new record must be submitted to create a new valid record.

Added for clarification

Correction method 1: send Delta

Delta may only be applied in XML data files WOK_Player_Account_Transaction and WWFT_Player_Account_Transaction. Operators must always correct for both types of records.

It is not mandatory to use Delta, for these two record types a Replacement correction can also be chosen. Note that this is a fixed choice and configuration. It cannot be changed without approval of Ksa.

To use the delta correction type, include the exact same data reported in the original record (Transaction_ID, Transaction_Type, Player_profile_ID, etc.). It is important that for each correction the same Transaction_ID shall be used, as was used in the original transaction reported.

The only fields that will differ are:

- Record_ID, this must always be unique, so different from the original record ID
- Transaction_datetime: with a delta this is the time when the transaction was corrected.
- Transaction_amount: Fill with the delta amount that must be corrected.

The amount can be positive or negative, for example:

- If the amount reported in the first record was 20 and the value after adjustment should be 30, then the reported delta amount is '10'
- If the amount reported in the first record was 20 and the value after correction should be 15, then the reported delta amount is "-5"

Correction method 1: send Delta has been voided on 25th April 2023, 09:34 hours UTC. This method must not be used.

Delta was absent in version 1.01. The delta function was published in a FAQ.

- If the amount reported in the first record was -16 (e.g. “stake”) and the value after adjustment should be -10, then the reported delta amount is '6'

Note #1 : the plus sign is an “invalid character”, therefore use is not allowed.

Note #2: When submitting delta records, the reported transaction amount must be taken into account for the calculation of the WOK player profile balance on the day the delta was submitted and for the data in wok operator of the day the delta was submitted.

Correction method 2: send replacement

Every XSD contains the field 'Replaced_Record_ID':

Field name	Minimum	Maximum	Data type
Replaced_Record_ID	0	1	UID

When this correction option is chosen, the most recent record in a chain of records and possible replacements will be cancelled. To create a new valid record, the operator must send a new record with the correct data. In this new record the operator must fill in the field 'Replaced_Record_ID' with the record ID of the original record to indicate which old record has to be replaced.

Added for clarification

Correction method 3: send cancellation

In case of cancellation, an XML file based on the XSD file 'Ksa_Cancellation' must be used. This XML can be used for cancellation of both WOK and WWFT records (note: the cancellation files must be placed in the corresponding root folder)

What?	Description
Field name	Ksa_Cancellation
Minimum	0
Maximum	1
Data type	n/a
Trigger	IF cancellation is required
Frequency	When needed

KSA_Type

Field name	Minimum	Maximum	Data type
KSA_Type	1	1	ksaType'

KSA type is the type of XSD was used to generate the data that is now cancelled.

Cancelled_Record_ID

Field name	Minimum	Maximum	Data type
Cancelled_Record_ID	0	1	UID ²

A cancelled record ID is the original record ID of the record that is cancelled.

5. WOK_Player_Profile

New triggers are added due to new insights

What?	Description
Field name	WOK_Player_Profile
Minimum	1
Maximum	No maximum
Data type	n/a
Trigger	<ol style="list-style-type: none"> 1. Already present players at the first moment of operation of the data safe: At the first moment of operation 2. New Player at registration, after the player has saved the profile, even if it is not yet completed 3. Existing player after saved change in profile 4. For all players with at least 1 transaction or correction during a day: 00:00 hours UTC the next day 5. All players present in the administration at the 1st of October 00:00 hours
Frequency	<p>@1. Once, at the start of a new safe;</p> <p>@2. After the player has saved changes in the profile;</p> <p>@3. After the player has saved the changes in the profile;</p> <p>@4. Once a day;</p> <p>@5. Once a year.</p>

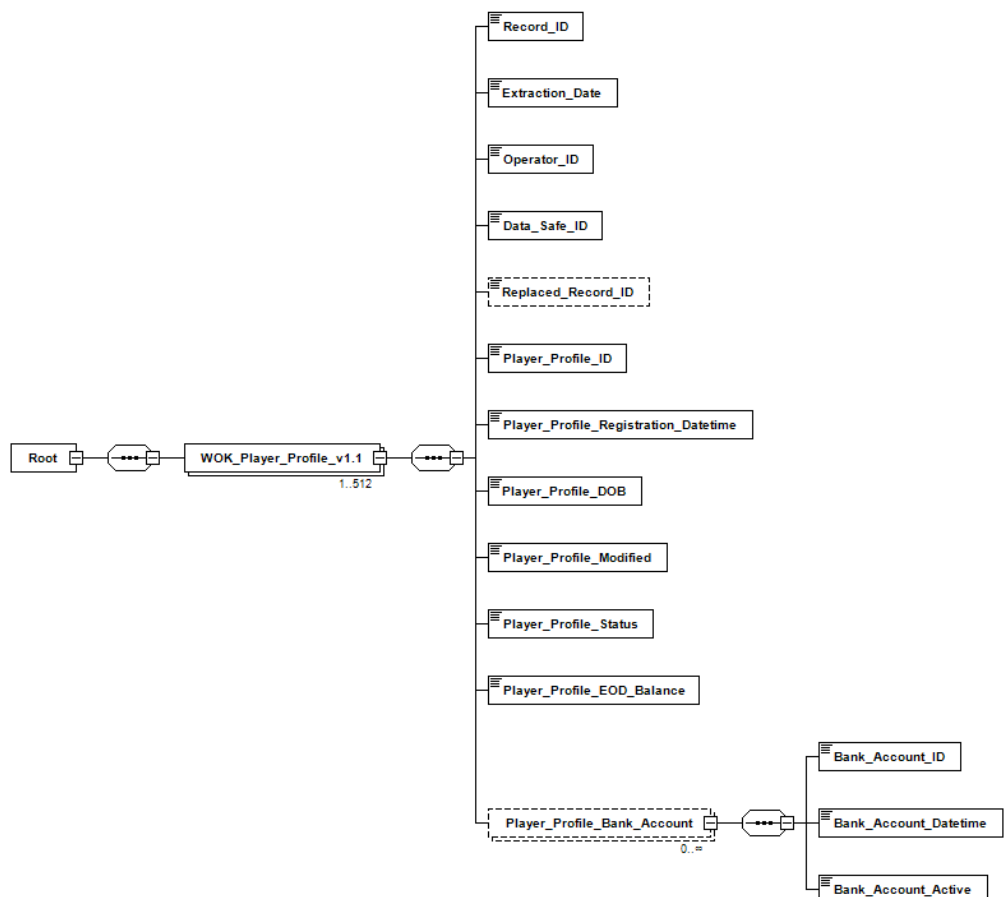

A player profile represents every customer who has ever registered, regardless of whether he or she has ever participated in any games or bets. It is not necessary to provide all player profiles, all the time. When a player profile is included, the entire profile must be submitted.

The first day of a new safe

When commissioning a completely new CDB, the player profiles of all available players must be sent at the first time or immediately after commissioning.

New player profiles and changed player profiles

After start of operation, only new player profiles and existing player profiles which have changed (except for changes in the "Player_Profile_EOD_Balance" field) need to be included.

The field "Player_Profile_EOD_Balance" represents the balance of the player profile at the moment of reporting. In some cases it may be impossible to determine a player profile balance of the day in question, in those cases take the player profile EOD balance of the previous day.

Player has performed one or more transactions on a day

If a player has had one or more transactions or corrections during the day, the player profile must be submitted at the end of the day. This player profile EOD balance must be in line with the actual balance at the end of the reporting day.

Once a year

At the 1st of October 00:00 of each year, all existing player profiles in the administration must be sent. In case of players with one or more transactions or corrections that day (Trigger #4), we expect just one record at the end of day to cover both trigger #4 and trigger #5.

Added for clarification and due to new insights

Player_Profile_ID

Field name	Minimum	Maximum	Data type
Player_Profile_ID	1	1	stringMedium ⁷

Player profile ID is the unique identification of a player within the operator. Any player profile ID may only occur once within an operator in all its history. Player profile ID must not be independently traceable to an (identified) natural person and also must not be traceable in combination with other data such as those relating to the interventions that an operator has made. Data is thus made available to the regulator pseudonymized.

The specifications document⁸ describes pseudonymisation.

⁷ See [stringMedium](#)

⁸ Ksa Requirements for the remote gambling datasafe (the CDB)

Player_Profile_Registration_Datetime

Field name	Minimum	Maximum	Data type
Player_Profile_Registration_Datetime	1	1	dateTimeUTC ⁹

Player profile registration date time is the time and date when the player profile ID was created by the operator. Generally this is the date when the player first created an account.

Player_Profile_DOB

Field name	Minimum	Maximum	Data type
Player_Profile_DOB	1	1	date

Player profile DOB is the player's date of birth.

Player_Profile_Modified

Field name	Minimum	Maximum	Data type
Player_Profile_Modified	1	1	dateTimeUTC

Player modified is the date when the sub elements under player were last modified. This means that every modification of a sub node of player means a modification of this field. If there never have been any changes, player profile modified is equal to the player profile registration date time. If there are multiple changes in a day, all records must be submitted.

⁹ See [dateTimeUTC](#)

Player_Profile_Status

Field name	Minimum	Maximum	Data type
Player_Profile_Status	1	1	Enumeration

A player profile status is the status a player has. A player can have the following statuses:

- ACTIVE: the player's identity has been verified and his/her status is normal;
- TRIAL: the verification of the player's identity is still ongoing, a player can only log in to complete the registration. Transactions and gambling are not allowed until the status ACTIVE is assigned;
- SUSPENDED: the player has been suspended by the operator due to not accessing his account for a certain amount of time;
- SUSPENDED_DEATH: the player has been suspended by the operator because he died;
- BLOCKED: the player's account has been blocked because the operator suspects fraudulent behaviour and/or the player does not meet the operator's terms and conditions;
- SELF_EXCLUDED_TEMP: the player has requested to be excluded from playing for a set period;
- SELF_EXCLUDED_INDEF: the player has requested to be excluded from playing for an indefinite period;
- OTHER: the player has another status not mentioned above.

Added for clarification, see "leidraad WWFT"¹⁰

It is possible that the regulator will add other options in the future.

Player_Profile_EOD_Balance

Field name	Minimum	Maximum	Data type
Player_Profile_EOD_Balance	1	1	monetaryAmount ¹¹

Player_Profile_EOD_Balance is the balance (in Euros) in the player account **at the moment of reporting**. Therefore it can be argued that the name doesn't cover the content, however we choose not to change the name of this field in this version of the data model.

The value of Player_Profile_EOD_Balance is determined by transactions that take place, such as a deposit, stake, winning or bonus award.

For all players with at least 1 transaction (or correction thereto) during 1 day, a WOK_Player_Profile must be sent at the end of that day containing the balance at the end of that day.

If a correction is applied to a transaction, settle the correction to the Player_Profile_EOD_Balance on the day of the correction. Do not retroactively adjust a Player_Profile_EOD_Balance.

Added for clarification and due to new insights

¹⁰ <https://kansspelautoriteit.nl/over-ons/publicaties/regels-leidraden/aanbieders-online-kansspelen/leidraad-wwft/>

¹¹ See [monetaryAmount](#)

Player_Profile_Bank_Account

Field name	Minimum	Maximum	Data type
Player_Profile_Bank_Account	0	No maximum	n/a

A player profile bank account is the bank account a player uses for withdrawals and deposits to the playing account used in the operator's system. There may be multiple bank accounts, but only one bank account can be active at a time. If the player's identity is still being verified, this field may be empty.

Under normal circumstances, only the active bank account is reported and not the entire bank account history. When the player modifies his or her bank account, two bank accounts are reported: the new active bank account (status TRUE) and the previous bank account (status FALSE).

Added for clarification

Bank_Account_ID

Field name	Minimum	Maximum	Data type
Bank_Account_ID	1	1	stringMedium ¹²

A bank account ID is the unique identification of a bank account within the operator's CDB. A bank account ID must be unique within the data of a player. This means that a single player cannot have two bank accounts with the same ID.

The bank account ID must not be independently traceable to an (identified) natural person and also must not be traceable in combination with other data such as those relating to the interventions that an operator has made. This data field is thus made available to the regulator pseudonymized.

DO NOT SEND IBANs

Do not send IBANs! The IBAN must be pseudonymized. Submitting of actual IBANs is a violation of the General Data Protection Regulation and a breach of the Governmental Decree remote gambling, article 5.3, second paragraph, under d.

The specifications document¹³ describes pseudonymisation.

Bank_Account_Datetime

Field name	Minimum	Maximum	Data type
Bank_Account_Datetime	1	1	dateTimeUTC ¹⁴

The bank account date time is the combination of date and time when the bank account ID was created in the operators systems.

Bank_Account_Active

Field name	Minimum	Maximum	Data type
Bank_Account_Active	1	1	boolean

Bank account active is an indication for a bank account whether or not this is the current bank account for the player account. There can only ever be one active bank account per player at a specific moment in time. When the player modifies his or her bank account, the previous bank account gets a value of **FALSE** for this field.

Added for clarification
Version 1.01 contained a clerical error (0 instead of FALSE)

¹² See [stringMedium](#)

¹³ Ksa Requirements for the remote gambling datasafe (the CDB)

¹⁴ See [dateTimeUTC](#)

RG_Class_Value

Field name	Minimum	Maximum	Data type
RG_Class_Value	1	1	stringShort ¹⁵

The field RG_Class_Value is the value of the risk class a player belongs to. The regulator does not make a limitative list – for now -, there should be at least be one class for young adults (18-24 years old) named “Young_Adult”. If no risk classification has been assigned, the value “NO_RISK_ASSIGNED” must be used. In case of multiple flags, the ‘heaviest’ risk flag must be assigned. This means for every active player profile there must be at least one flag on any given moment.

Added for clarification

RG_Class_Datetime

Field name	Minimum	Maximum	Data type
RG_Class_Datetime	1	1	dateTimeUTC ¹⁶

The field RG_Class_Datetime is the combination of the date and time when the value of the risk class a player belongs to was last changed.

¹⁵ See [stringShort](#)

¹⁶ See [dateTimeUTC](#)

7. WOK_Player_Account_Transaction

What?	Description
Field name	WOK_Player_Account_Transaction
Minimum	1
Maximum	No maximum
Data type	n/a
Trigger	<ol style="list-style-type: none"> 1. A game session has ended: A transaction in WOK_Player_Account_Transaction is created when a game session is ended. For each game session all transactions from the player account to the game (the stakes) and all transactions from the game to the player account (the winnings) should be grouped by game session level. A game session therefore has at least 1 transaction (the sum of the STAKES) and in case of at least one winning, also a second transaction (the sum of the WINNINGS) 2. All other transactions: A transaction in WOK_Player_Account_Transaction is created whenever a transaction is attempted, even if it is unsuccessful. This includes the setting aside or earmarking funds in the player account (sometimes known as 'exposure') for bets which have not been settled yet.
Frequency	<ol style="list-style-type: none"> 1. Immediately after a game session is ended. 2. Immediately after a transaction is attempted.

Added due to new insights

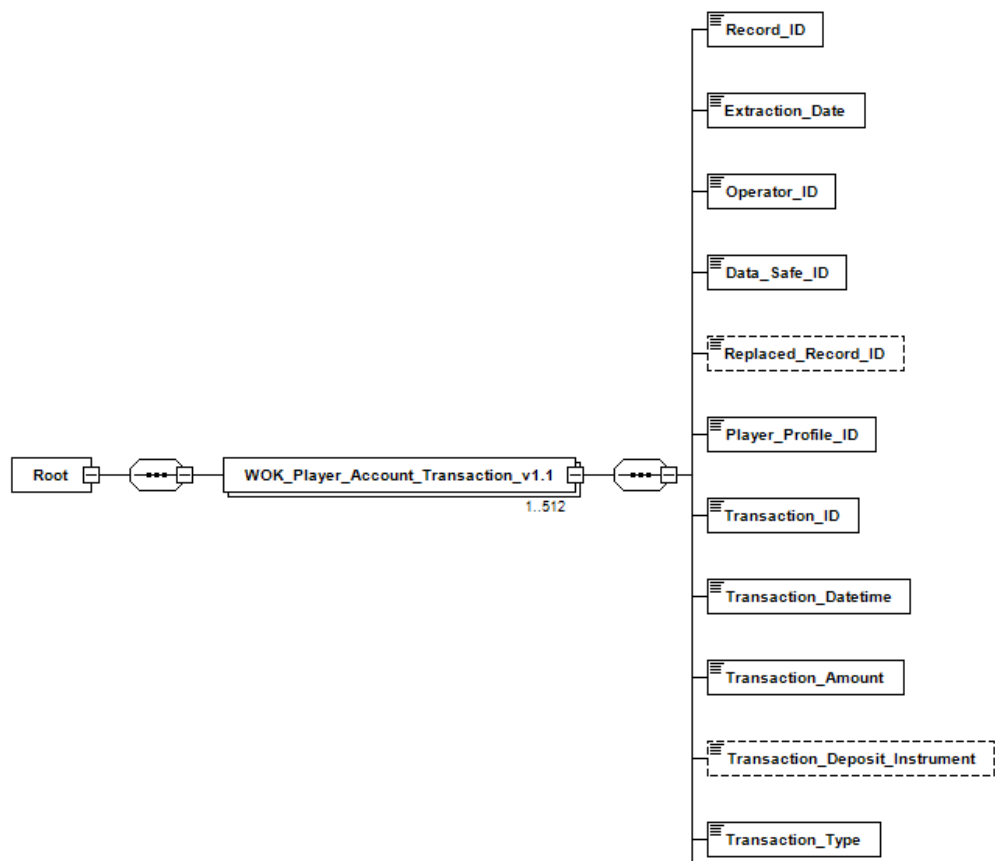

WOK_Player_Account_Transaction represents:

- a single transaction to or from the player account
- or in case of transactions during a game session, the summed total of the stakes and winnings respectively.

Game session transactions:

Given the possible large number of transactions in a single game session, transactions from the player account to the game (the stakes) and the transactions from the game to the player account (the winnings) should be grouped on game session level. A game session therefore has at least 1 transaction (the sum of the STAKES) and in case of at least one winning, also a second transaction (the sum of the WINNINGS).

The trigger for these two cumulative transactions is equivalent to providing the corresponding game session: “When a game session is ended”. If a game session lasts over midnight, then all stakes and winnings will count towards the next day's subtotal **as far as the CDB of the Ksa is concerned**. For other reports such as Tax return, other definitions may apply.

Other transactions

All other transactions are reported in a single transaction. A WOK_Player_Account_Transaction record is created whenever a transaction is attempted, even if it is unsuccessful. This includes the setting aside or earmarking funds in the player account (sometimes known as ‘exposure’) for bets which have not been settled yet.

Player_Profile_ID

See [Player_Profile_ID](#)

Added due to new insights

Transaction_ID

Field name	Minimum	Maximum	Data type
Transaction_ID	1	1	UID ¹⁷

Transaction ID is the unique identifier of any transaction on a player account. A transaction ID may occur only once in combination with a player account. A single operator cannot have multiple transactions with the same transaction ID and the same player profile ID.

Transaction_Datetime

Field name	Minimum	Maximum	Data type
Transaction_Datetime	1	1	dateTimeUTC ¹⁸

Transaction date time is the combination of date and time when the transaction was finished or aborted, i.e. when the transaction (attempt) was finished.

Transaction_Amount

Field name	Minimum	Maximum	Data type
Transaction_Amount	1	1	monetaryAmount ¹⁹

Transaction amount is the transaction's amount in EURO. This may be a positive or a negative number. If funds have been deducted from the player account, the amount must be preceded by a minus sign. If the funds have been added to the player account, the amount has no sign.

Transaction_Deposit_Instrument

Field name	Minimum	Maximum	Data type
Transaction_Deposit_Instrument	0	1	Enumeration

Transaction deposit instrument is an indication of the payment method of the transaction. For this field, the options are:

- CREDIT_CARD;
- ELECTRONIC_MONEY;
- BANK_TRANSFER;
- OTHER.

It is possible that the regulator will add other options in the future. **This field is mandatory in case of a deposit transaction and can only be filled in in case of deposit transaction.**

Added for clarification

¹⁷ See [UID](#)

¹⁸ See [dateTimeUTC](#)

¹⁹ See [monetaryAmount](#)

Transaction_Type

Field name	Minimum	Maximum	Data type
Transaction_Type	1	1	Enumeration

Transaction type is an indication for which reason the transaction took place.

For this field, the options are:

- DEPOSIT: the player transferred money with his deposit instrument of choice to his player account;
- WITHDRAWAL: the player transferred money from his player account to his bank account;
- WINNING: the player won money in a game or a bet;
- BONUS: the player earned a bonus;
- STAKE: the player lays money on a betting event;
- CASH_OUT: a partial cash out was made while the sports event to which a bet pertained was still ongoing;
- VOID_BET: the stake is returned, that is the player has not won any money but did not lose it either;
- VOID_STAKE: the (partial) stake of a game is returned. For instance, when a player buys entry into a poker tournament in advance, but decides not to participate before the start of the tournament. The player receives the (partial) return of the stake. Also, in some cases, a stake has been placed, and player input is needed to actually finish the game (e.g. black jack). But due to some error, the game is interrupted.
- BONUS_CANCELLED: The bonus is cancelled by the customer or by the operator;
- BONUS_EXPIRED: the bonus has expired;
- RESETTLEMENT: From time to time obvious errors are made, either through human or system error, and bets are accepted at a price that is materially different from those available in the general market or clearly incorrect given the chance of the event happening at the time the bet was struck;
- OTHER.

Added due to new insights

It is possible that the regulator will add other options in the future.

Transaction_Status

Field name	Minimum	Maximum	Data type
Transaction_Status	1	1	Enumeration

Transaction type indicates if an attempted transaction was successful or not.

The options are:

- SUCCESSFUL – the transaction was successful.
- UNSUCCESSFUL - the transaction was unsuccessful.

The status of the transaction was absent

WWFT_Player_Account_transaction records must not be used.

8. WWFT_Player_Account_Transaction

What?	Description
Field name	WWFT_Player_Account_Transaction
Minimum	0
Maximum	No maximum
Data type	n/a
Trigger	<ol style="list-style-type: none"> 1. A game session is ended: A transaction in WOK_Player_Account_Transaction is created when a game session is ended. For each game session all transactions from the player account to the game (the stakes) and all transactions from the game to the player account (the winnings) should be grouped by game session level. A game session therefore has at least 1 transaction (the sum of the STAKES) and in case of at least one winning, also a second transaction (the sum of the WINNINGS) 2. All other transactions: A WWFT_Player_Account_Transaction is created whenever a transaction is attempted, even if it is unsuccessful. This includes the setting aside or earmarking funds in the player account (sometimes known as 'exposure') for bets which have not been settled yet.
Frequency	@1: Immediately after a game session is ended. @2: Immediately after a transaction is attempted.

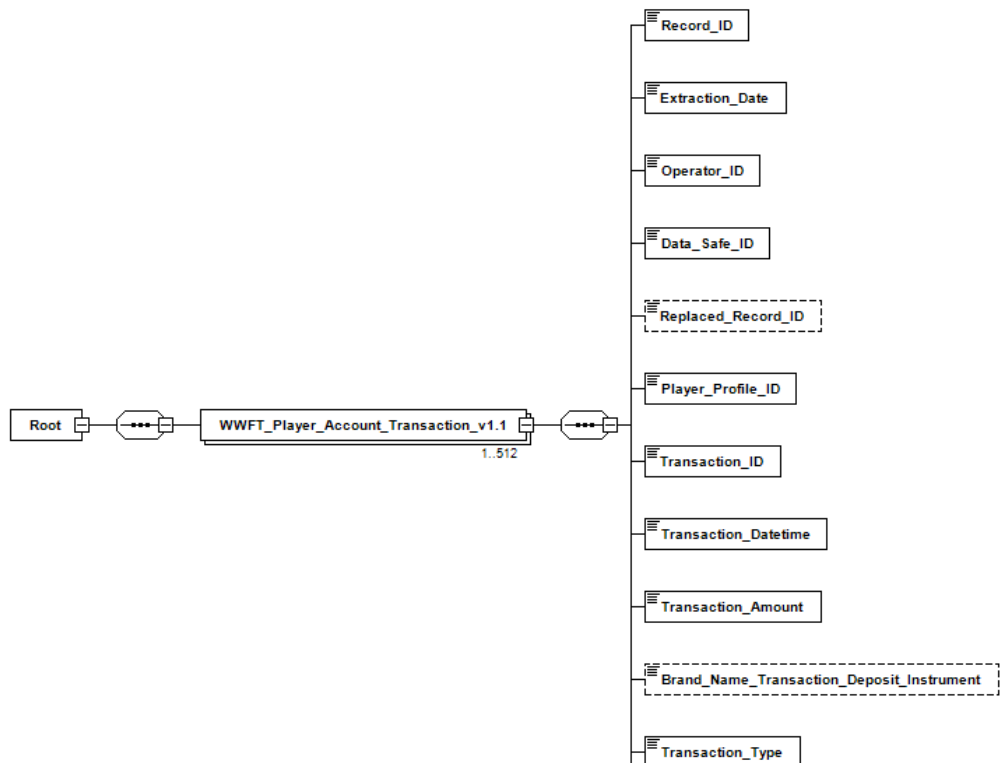

WWFT_Player_Account_Transaction represents:

- a single transaction to or from the player account
- or in case of transactions during a game session, the summed total of the stakes and winnings respectively.

Game session transactions:

Given the possible large number of transactions in a single game session, transactions from the player account to the game (the stakes) and the transactions from the game to the player account (the winnings) should be grouped on game session level. A game session therefore has at least 1 transaction (the sum of the STAKES) and in case of at least one winning, also a second transaction (the sum of the WINNINGS).

The trigger for these two cumulative transactions is equivalent to providing the corresponding game session: "When a game session is ended". If a game session lasts over midnight, then all stakes and winnings will count towards the next day's subtotal **as far as the CDB of the Ksa is concerned**. For other reports such as Tax return, other definitions may apply.

Other transactions

All other transactions are reported in a single transaction. A WWFT_Player_Account_Transaction is created whenever a transaction is attempted, even if it is unsuccessful. This includes the setting aside or earmarking funds in the player account (sometimes known as 'exposure') for bets which have not been settled yet.

Player_Profile_ID

See [Player_Profile_ID](#)

Added due to new insights

Transaction_ID

Field name	Minimum	Maximum	Data type
Transaction_ID	1	1	UID ²⁰

Transaction ID is the unique identifier of any transaction on a player account. A transaction ID may occur only once in combination with a player account. A single operator cannot have multiple transactions with the same transaction ID and the same player profile ID.

Transaction_Datetime

Field name	Minimum	Maximum	Data type
Transaction_Datetime	1	1	dateTimeUTC ²¹

Transaction date time is the combination of date and time when the transaction was finished or aborted, i.e. when the transaction (attempt) was finished.

Transaction_Amount

Field name	Minimum	Maximum	Data type
Transaction_Amount	1	1	monetaryAmount ²²

Transaction amount is the transaction's amount in EURO. This may be a positive or a negative number. If funds have been deducted from the player account, the amount must be preceded by a minus sign. If the funds have been added to the player account, the amount has no sign.

Brand_Name_Transaction_Deposit_Instrument

Field name	Minimum	Maximum	Data type
Brand_Name_Transaction_Deposit_Instrument	0	1	stringMedium

Brand_Name_Transaction_Deposit_Instrument is the brand name of the deposit instrument used, such as the name of the bank in case of electronic bank transfer, the name of the electronic wallet, the name of the credit card. It is not the name of the Payment Service Provider (PSP). In case a PSP is used, the name of the source of the money should be used, such as the name of the bank.

Naming is now in line with the xsd

²⁰ See [UID](#)

²¹ See [dateTimeUTC](#)

²² See [monetaryAmount](#)

Transaction_Type

Field name	Minimum	Maximum	Data type
Transaction_Type	1	1	Enumeration

Transaction type is an indication for which reason the transaction took place. For this field, the options are:

- DEPOSIT: the player transferred money from his bank account to his player account;
- WITHDRAWAL: the player transferred money from his player account to his bank account;
- WINNING: the player won money in a game or a bet;
- BONUS: the player earned a bonus;
- STAKE: the player lays money on a betting event
- CASH_OUT: a partial cash out was made while the sports event to which a bet pertained was still ongoing;
- VOID_BET: the stake is returned, that is the player has not won any money but did not lose it either;
- VOID_STAKE: the (partial) stake of a game is returned. For instance, when a player buys entry into a poker tournament in advance, but decides not to participate before the start of the tournament. The player receives the (partial) return of the stake. Also, in some cases, a stake has been placed, and player input is needed to actually finish the game (e.g. black jack). But due to some error, the game is interrupted.
- BONUS_CANCELLED: The bonus is cancelled by the customer or by the operator;
- BONUS_EXPIRED: the bonus has expired;
- RESETTLEMENT: From time to time obvious errors are made, either through human or system error, and bets are accepted at a price that is materially different from those available in the general market or clearly incorrect given the chance of the event happening at the time the bet was struck;
- OTHER.

It is possible that the regulator will add other options in the future.

Transaction_Status

Field name	Minimum	Maximum	Data type
Transaction_Status	1	1	Enumeration

Transaction status indicates if an attempted transaction was successful or not.

The options are:

- SUCCESSFUL – the transaction was successful.
- UNSUCCESSFUL - the transaction was unsuccessful.

Added due to new insights

The transaction status was absent

9. WOK_Player_Limits

What?	Description
Field name	WOK_Player_Limits
Minimum	1
Maximum	No maximum
Data type	n/a
Trigger	<p>When the limit comes into effect: For example:</p> <ul style="list-style-type: none"> - Creation of new player account; - If a limit is changed and comes into effect immediately: the change of the limit; - If a limit is changed, and the limit comes on a later day into effect: the day when the limit comes into effect.
Frequency	<p>Immediately after the limit comes into effect;</p> <p>Or</p> <p>At the start of the day the limit comes into effect.</p>

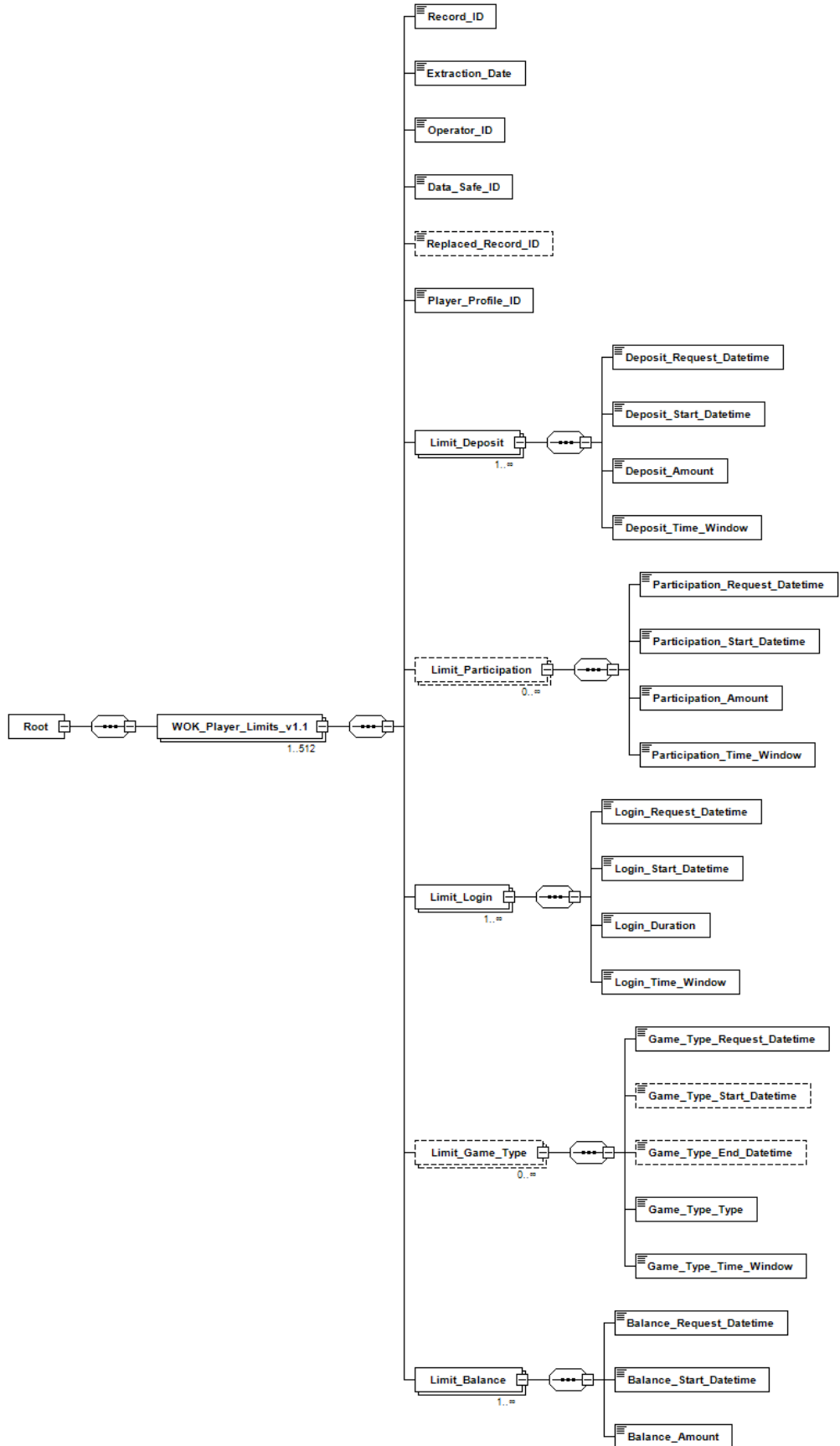

WOK_Player_Limits is a parent element for player limits. Player limits can be set by the player or the operator. The limits listed below must always be present from the moment the player registers.

If a limit is changed, a new record is created. Old limits are therefore not changed, removed, or cancelled. If there are more limits of one type for one player the date/time shows which limit is active. The only exception is the limit for a game type. Of this limit, more can be active at the same time. That is the reason that this limit also has an end date.

Player_Profile_ID

See [Player_Profile_ID](#)

Limit_Deposit

Field name	Minimum	Maximum	Data type
Limit_Deposit	1	No maximum	n/a

A deposit limit is the limitation of the amount of money that a player may deposit into his player account.

Deposit_Request_Datetime

Field name	Minimum	Maximum	Data type
Deposit_Request_Datetime	1	1	dateTimeUTC ²³

Deposit request date time is the combination of the date and time when the deposit limit is created.

Deposit_Start_Datetime

Field name	Minimum	Maximum	Data type
Deposit_Start_Datetime	1	1	dateTimeUTC ²⁴

Deposit start date time is the combination of the date and time when the deposit limit comes into effect

²³ See [dateTimeUTC](#)

²⁴ See [dateTimeUTC](#)

Previous data type was Integer, an unbounded value. With Int, a maximum is set.

Deposit_Amount

Field name	Minimum	Maximum	Data type
Deposit_Amount	1	1	Int

A deposit amount is the maximum amount (rounded to whole euros) that can be deposited into the player account per period specified in in the time window of the deposit limit. This can only happen through a request by the player himself and affects only transactions of transaction type DEPOSIT.

Deposit_Time_Window

Field name	Minimum	Maximum	Data type
Deposit_Time_Window	1	1	timeWindow ²⁵

Deposit time window is the time interval to which the deposit limit applies.

Limit_Participation

Field name	Minimum	Maximum	Data type
Limit_Participation	0	No maximum	n/a

Limit_Participation represents the limitation of the player's stake.

Participation_Request_Datetime

Field name	Minimum	Maximum	Data type
Participation_Request_Datetime	1	1	dateTimeUTC ²⁶

Participation request date time is the combination of date and time when the participation limit was created.

Participation_Start_Datetime

Field name	Minimum	Maximum	Data type
Participation_start_Datetime	1	1	dateTimeUTC ²⁷

Participation start date time is the combination of date and time when the participation limit comes into effect.

²⁵ See [timeWindow](#)

²⁶ See [dateTimeUTC](#)

²⁷ See [dateTimeUTC](#)

Previous data type was Integer, an unbounded value. With Int, a maximum is set.

Participation_Amount

Field name	Minimum	Maximum	Data type
Participation_Amount	1	1	Int

A participation amount is the maximum stake (rounded in euros) that the player may bet per period specified in the participation time window.

Participation_Time_Window

Field name	Minimum	Maximum	Data type
Participation_Time_Window	1	1	timeWindow ²⁸

A participation time window is the time interval to which the participation limit applies.

Limit_Login

Field name	Minimum	Maximum	Data type
Limit_Login	1	No maximum	n/a

A login limit is the limitation on the duration a player can log onto the player account. Having such a limitation is mandatory based on the remote gambling decree (Besluit kansspelen op afstand).

Login_Request_Datetime

Field name	Minimum	Maximum	Data type
Login_Request_Datetime	1	1	dateTimeUTC ²⁹

A login request date time is the combination of date and time when the login limit is created.

Login_Start_Datetime

Field name	Minimum	Maximum	Data type
Login_Start_Datetime	1	1	dateTimeUTC ³⁰

Login start date time is the combination of date and time when the login limit comes into effect.

²⁸ See [timeWindow](#)

²⁹ See [dateTimeUTC](#)

³⁰ See [dateTimeUTC](#)

Login_Duration

Field name	Minimum	Maximum	Data type
Login_Duration	1	1	xs:float

A login duration is the maximum duration a player can be logged in onto the player interface, per period specified in the login time window.

Login_Time_Window

Field name	Minimum	Maximum	Date type
Login_Time_Window	1	1	timeWindow ³¹

Login time window is the time interval to which the login limit applies.

Limit_Game_Type

Field name	Minimum	Maximum	Data type
Limit_Game_Type	0	No maximum	n/a

A game type limit is an exclusion of a certain game type. It is possible that a player has multiple active limits of this type, in case a player is excluded for more than one game type.

Game_Type_Request_Datetime

Field name	Minimum	Maximum	Data type
Game_Type_Request_Datetime	1	1	dateTimeUTC ³²

Game type request date time is the combination of date and time when the limit was created.

Game_Type_Start_Datetime

Field name	Minimum	Maximum	Data type
Game_Type_Start_Datetime	0	1	dateTimeUTC

Game type start date time is the combination of date and time when the game type limit comes into effect. This field is optional, if a game type limit is ended, this field can be omitted.

³¹ See [timeWindow](#)

³² See [dateTimeUTC](#)

Game_Type_End_Datetime

Field name	Minimum	Maximum	Data type
Game_Type_End_Datetime	0	1	dateTimeUTC

Game type end date time is the combination of date and time when the limit ended. This field is optional, if a limit is still active, this field can be omitted.

Game_Type_Type

Field name	Minimum	Maximum	Data type
Game_Type_Type	1	1	stringMedium ³³

A type of game type is the game type the player is excluded from. This field may contain game types for which there is currently no legal basis but which are set up for future developments and for supervisory purposes.

Game_Type_Time_Window

Field name	Minimum	Maximum	Data type
Game_Type_Time_Window	1	1	timeWindow ³⁴

A game type time window is the time interval to which the game type limit applies.

Limit_Balance

Field name	Minimum	Maximum	Data type
Limit_Balance	1	No maximum	n/a

A balance limit is the limitation of the amount of money that a player may have in his player account.

Balance_Request_Datetime

Field name	Minimum	Maximum	Data type
Balance_Request_Datetime	1	1	dateTimeUTC ³⁵

Balance request date time is the combination of the date and time when the balance limit was created.

³³ See [stringMedium](#)

³⁴ See [timeWindow](#)

³⁵ See [dateTimeUTC](#)

Balance_Start_Datetime

Field name	Minimum	Maximum	Data type
Balance_Start_Datetime	1	1	dateTimeUTC

Balance start date time is the combination of the date and time when the balance limit comes into effect.

Balance_Amount

Field name	Minimum	Maximum	Data type
Balance_Amount	1	1	Int

Balance amount is the maximum amount (rounded to whole euros) that can be in the player's account at the end of a session.

Previous data type was Integer, an unbounded value. With Int, a maximum is set.

10. WOK_Intervention

What?	Description
Field name	WOK_Intervention
Minimum	1
Maximum	No maximum
Data type	n/a
Trigger	An intervention is performed by the operator.
Frequency	Immediately after the start of the intervention

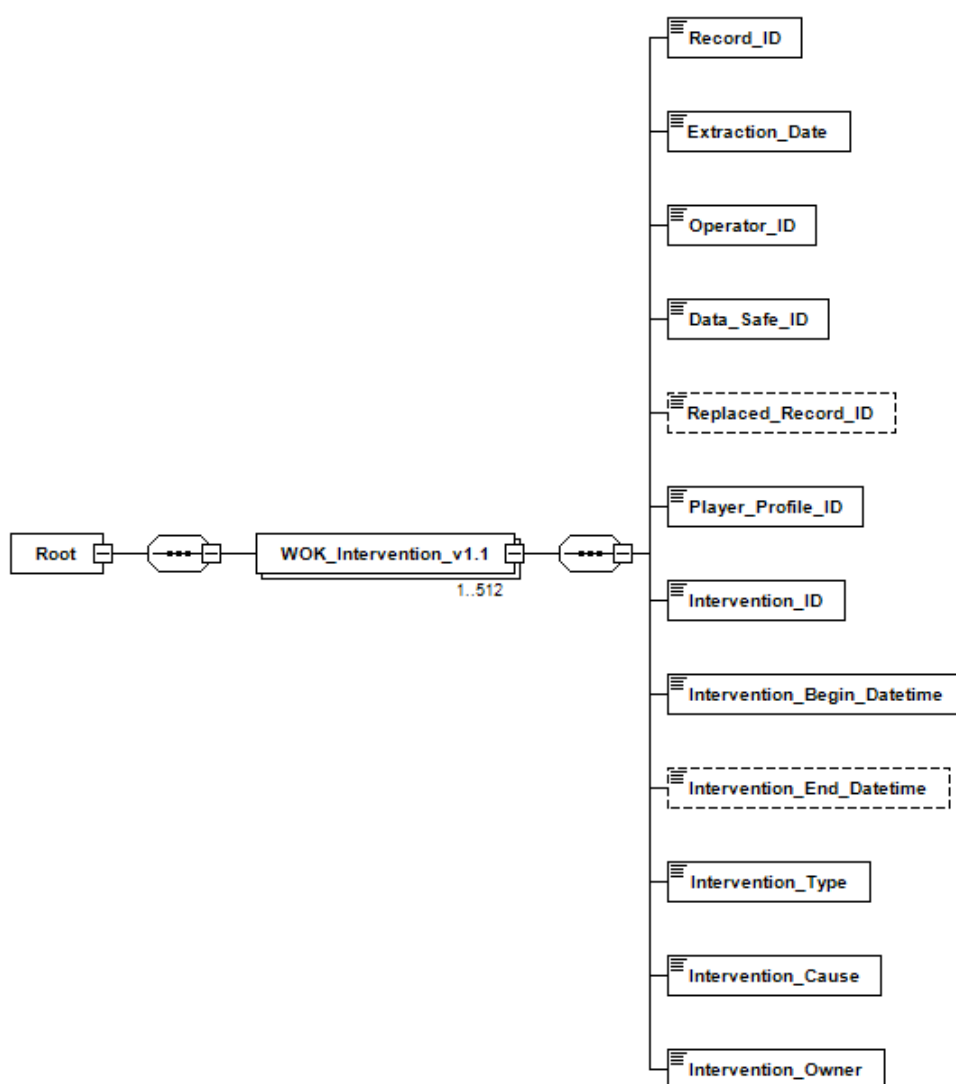

WOK_Intervention represents an intervention by the operator in connection with addiction prevention or (a suspicion of) fraud by a player.

Player_Profile_ID

See [Player_Profile_ID](#)

Intervention_ID

Field name	Minimum	Maximum	Data type
Intervention_ID	1	1	UID ³⁶

Intervention ID is a unique identification of an intervention within the data of a player. I.e. one player may not have two interventions with the same ID.

Intervention_Begin_Datetime

Field name	Minimum	Maximum	Data type
Intervention_Begin_Datetime	1	1	dateTimeUTC ³⁷

Intervention begin date time is the combination of the date and time when the intervention started or, in case of a short-term action like setting a limit, when the action was taken.

Intervention_End_Datetime

Field name	Minimum	Maximum	Data type
Intervention_End_Datetime	0	1	dateTimeUTC

Intervention end date time is the combination of date and time when the intervention ended. This field is optional and does not have to be included in interventions that consist of a short-term action such as setting a limit.

Intervention_Type

Field name	Minimum	Maximum	Data type
Intervention_Type	1	1	Enumeration

Intervention type is a categorisation of the intervention activity. Intervention is a response to an action or set of actions by a player. Interventions are often linked to a flag related to problem gambling or (suspicion of) fraud, but there may also be other reasons, e.g. misbehaviour towards customer service.

Accepted values are:

- CONVERSATION_V_INFORM: a voice conversation (phone call) with the purpose of warning the player about the risk of problematic gambling and/or informing the player about means by which he or she can gain insight into his own gambling habits;
- CONVERSATION_V_ANNOUNCE: a voice conversation (phone call) with the purpose of announcing that the operator intends to take some action, like blocking the player's access or setting a limit;

³⁶ See [UID](#)

³⁷ See [dateTimeUTC](#)

- CONVERSATION_T_INFORM: a message via e-mail, a popup or some other means of written communication with the purpose of warning the player about the risk of problematic gambling and/or informing the player about means by which he or she can gain insight into his own gambling habits;
- CONVERSATION_T_ANNOUNCE: a message via e-mail or some other means of written communication with the purpose of announcing that the operator intends to take some action, like blocking the player’s access or setting a limit;
- SET_FLAG: a flag has been set for this player;
- SET_LIMIT: a limit has been set for this player by the operator;
- EXCLUDE: a player has been excluded (permanently or temporarily) from the gambling platform by the operator;
- OTHER.

It is possible that the regulator will add other options in the future.

Intervention_Cause

Field name	Minimum	Maximum	Data type
Intervention_Cause	1	1	Enumeration

Intervention cause is the reason for carrying out the intervention, for example in case of exceeding limits. Accepted values are:

- FRAUD: the player has been involved in (suspected) fraudulent behaviour;
- SOCIAL: the player has misbehaved, for example by using abusive language towards staff or other players;
- PROBLEM_GAMBLING: the player has shown behaviour which indicates there is a risk of gambling addiction;
- OTHER.

It is possible that the regulator will add other options in the future.

Intervention_Owner

Field name	Minimum	Maximum	Data type
Intervention_Owner	1	1	stringMedium ³⁸

Intervention owner is the name of the business unit or person who carried out the intervention.

³⁸ See [stringMedium](#)

11. WOK_Game

What?	Description
Field name	WOK_Game
Minimum	0
Maximum	No Maximum
Data type	n/a
Trigger	<ol style="list-style-type: none"> At the start of the first day of operation of the CDB; When a game becomes available (again) to the players, as soon as possible; When a game is retracted, 00:00 hours the day after; When the name of a game is changed.
Frequency	@1: Once, at the start of the first day of operation of the CDB @2: Once, on the day the game becomes (re)available @3: at the beginning of the day the game is retracted @4: Once when the name of a game is changed

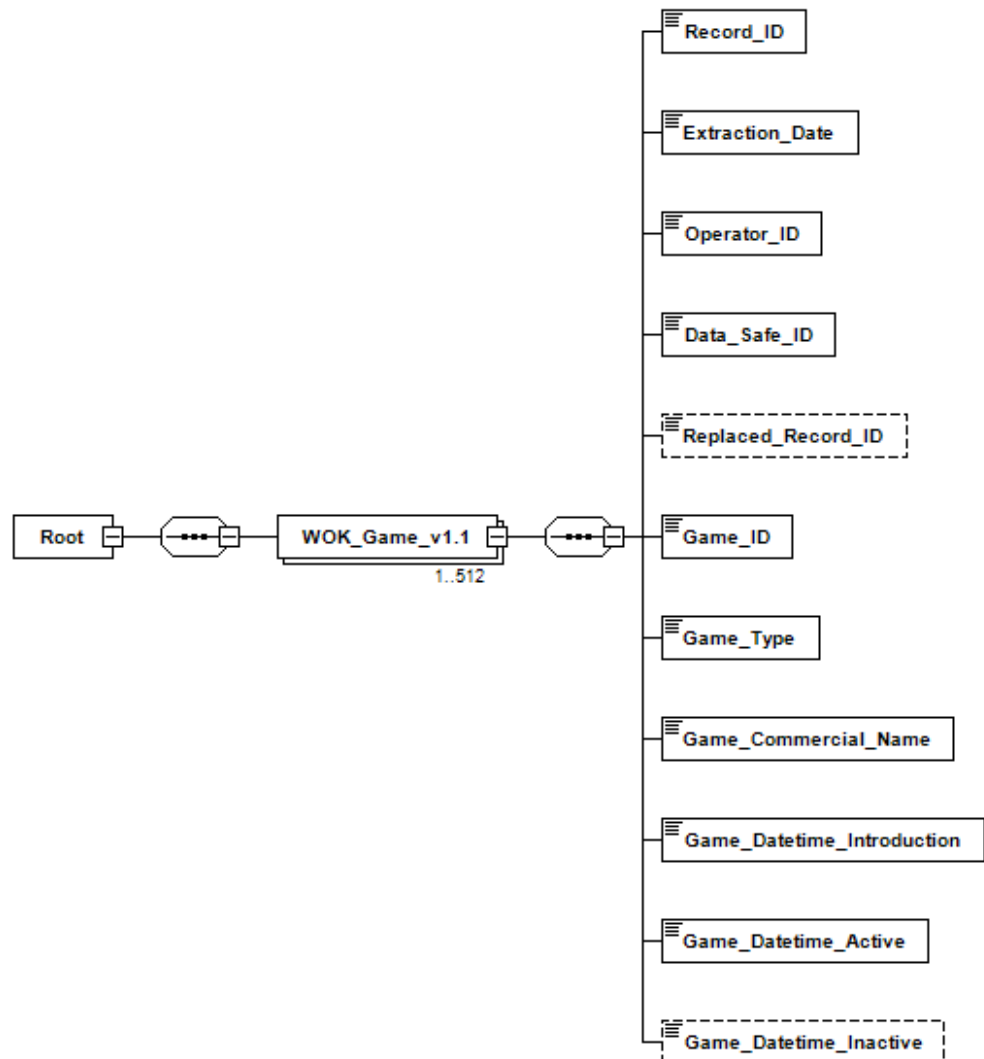

Added for clarification

WOK_Game represents a game of chance offered by the operator. This does not include bets. This information is optional, if only bets are offered, it does not have to be included.

Games only need to be included if something changes, e.g. a game becomes available or unavailable to players. Games must be reported as active before a game session can include that game.

When the name of a game is changed, first send a record with the old name and the date and time of inactivation. Subsequently, send a record with the same Game ID but with the new name and the new activation date and time.

Game_ID

Field name	Minimum	Maximum	Data type
Game_ID	1	1	UID ³⁹

Game ID is a unique identification of a game within the operators CDB. I.e. one operator may not have two games with the same ID.

Game_Type

Field name	Minimum	Maximum	Data type
Game_Type	1	1	Enumeration

Game_Type is the type of the game. Accepted values are;

- SLOTS;
- CASINO;
- BINGO;
- VIRTUAL_SPORTS;
- OTHER.

Virtual Sports are considered as games not bets. This is due to the use of a random number generator and the short odd nature of such games. Played virtual sport games shall be reported with game sessions, see 12 WOK_GAME_SESSION.

Added due to new insights

It is possible that the regulator will add other options in the future.

Game_Commercial_Name

Field name	Minimum	Maximum	Data type
Game_Commercial_Name	1	1	stringMedium ⁴⁰

Game commercial name is the name of the game as it is shown to the player.

³⁹ See [UID](#)

⁴⁰ See [stringMedium](#)

Game_Datetime_Introduction

Field name	Minimum	Maximum	Data type
Game_Datetime_Introduction	1	1	dateTimeUTC ⁴¹

Game date time introduction is the combination of the date and time when a game became available to players for the very first time.

⁴¹ See [dateTimeUTC](#)

Game_Datetime_Active

Field name	Minimum	Maximum	Data type
Game_Datetime_Active	1	1	dateTimeUTC

Game date time active is the combination of the date and time when a game became available to players. If the game has always been available since it was first introduced, the value is equal to the value of the field Game_Datetime_Introduction. If a game was temporarily withdrawn and then becomes available again, the game date time active is updated. The Game ID must not change in such a case.

Game_Datetime_Inactive

Field name	Minimum	Maximum	Data type
Game_Datetime_Inactive	0	1	dateTimeUTC

Game date time inactive is the combination of the date and time when a game stops being available to players.

12. WOK_Game_Session

What?	Description
Field name	WOK_Game_Session
Minimum	1
Maximum	No maximum
Data type	n/a
Trigger	When a Game_Session is ended
Frequency	Immediately after a Game_session is ended

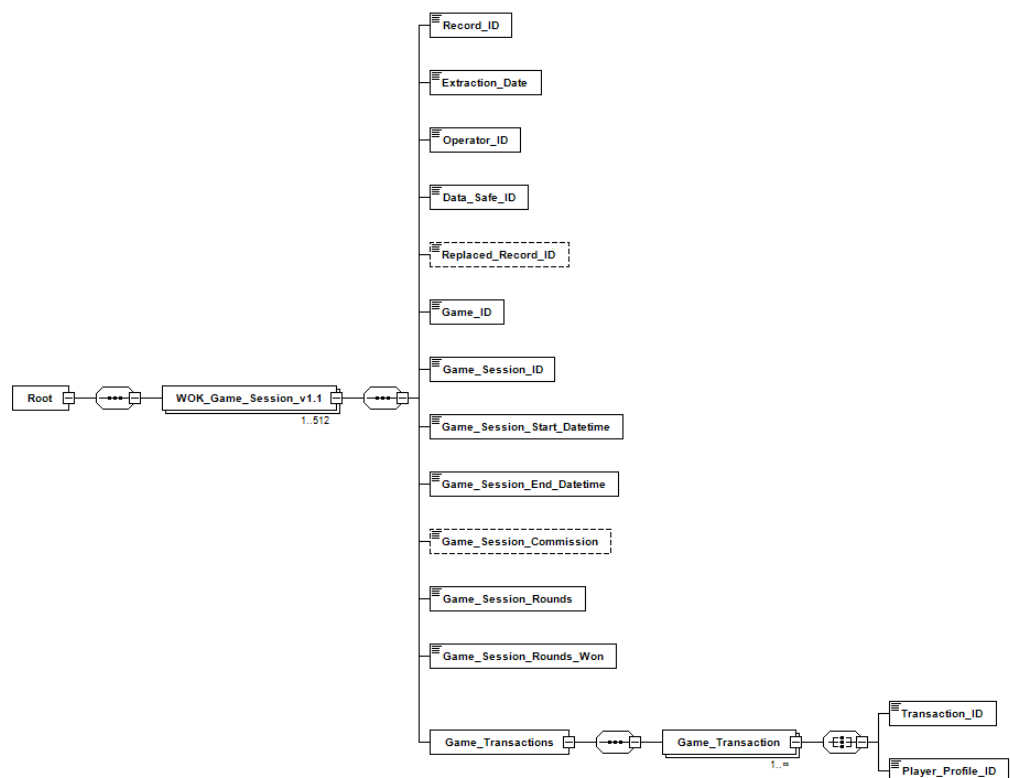

WOK_Game_Session represents the period that a player starts an individual game until the moment that specific game is ended. In this definition the way the game is ended is not relevant. Ending a game could be done by the player, automatic by the game, a session time-out, by the operator or any other trigger or reason. When the player restarts the game after a closure, it should be regarded as a new game session.

Please note that a game session is not the period between logging on and off on the player interface of the “gambling interface”. Therefore, in the time between logging on and off, multiple game sessions may occur.

Within one game session, multiple transactions may occur for example after each spin in a casino game.

All these transactions from player account to the game (STAKE) and from the game to the player account (WINNING) should be accumulated to one level.

Added for clarification

Therefore a game session has at least 1 transaction (the sum of the STAKES) and in case of a winning also a second transaction (the sum of the WINNINGS).

If a game session lasts over midnight, the game session is reported on the day the game session is ended. The result of that game session should be reported as part of the WOK operator file of the day the game session is closed.

All transaction types other than STAKE and WINNING are always reported on an individual level.

Game_ID

See [Game_ID](#)

Game_Session_ID

Field name	Minimum	Maximum	Data type
Game_Session_ID	1	1	UID ⁴²

Game session ID is the unique identification of a game session which must be unique within the data of a game. I.e. one game may not have two sessions with the same ID.

⁴² See [UID](#)

Game_Session_Start_Datetime

Field name	Minimum	Maximum	Data type
Game_Session_Start_Datetime	1	1	dateTimeUTC ⁴³

Game session start date time is the combination of the date and time when the game session was started.

Game_Session_End_Datetime

Field name	Minimum	Maximum	Data type
Game_Session_End_Datetime	1	1	dateTimeUTC

Game session end date time is the combination of the date and time when the game session ended.

Game_Session_Commission

Field name	Minimum	Maximum	Data type
Game_Session_Commission	0	1	monetaryAmount

Game session commission is the total amount of commission that has been withheld during the game session by the operator, for example an entry fee or the rake at poker. This field is optional, for game types where no commission is withheld, it does not have to be included.

Game_Transactions

Field name	Minimum	Maximum	Data type
Game_Transactions	1	1	n/a

Game_Transactions is a reference to a summarized transaction to or from a player account that is related to this game session.

Game_Session_Rounds

Field name	Minimum	Maximum	Data type
Game_Session_Rounds	1	1	Int

Game session rounds is the total amount of 'rounds' played in a Game Session. A round is for instance a spin on the roulette wheel or a spin on a virtual slot machine. In case of poker, a round is defined as a single hand (game), i.e. from the dealing of the cards (or start of the bidding, depending on the specific type) to the taking of the pot of that hand by the player(s) holding the winning cards.

Added due to new insights

⁴³ See [dateTimeUTC](#)

Game_Session_Rounds_Won

Field name	Minimum	Maximum	Data type
Game_Session_Rounds_Won	1	1	Int

Added due to new insights

Game session rounds won is the total amount of 'rounds' played in a Game Session that resulted in a winning.

Player_Profile_ID

See [Player_Profile_ID](#)

Transaction_ID

See [Transaction_ID](#)

13. WOK_Bet

What?	Description
Field name	WOK_Bet
Minimum	1
Maximum	No maximum
Data type	n/a
Trigger	<ol style="list-style-type: none"> 1. A Bet is placed and accepted 2. A Bet is settled or cancelled
Frequency	<ol style="list-style-type: none"> 1. Immediately after the bet has been accepted 2. Immediately after a bet is completed or cancelled

WOK_Bet represents a placed and accepted bet or a settled or cancelled bet. If no bets have been completed or cancelled within the reporting period, no data of already accepted bets will be submitted. This data follows when the bets have been settled or cancelled.

Virtual Sports are considered games and not bets. This is due to the use of a random number generator and the short odd nature of such games. Played virtual sport games shall be reported with game sessions, see 12 WOK_GAME_SESSION

Added due to new insights

Bet_ID

Field name	Minimum	Maximum	Data type
Bet_ID	1	1	UID ⁴⁴

A Bet ID is the unique identification of a bet which must be unique within the data of an operator. I.e. one operator may not ever have two bets with the same ID.

Bet_Start_Datetime

Field name	Minimum	Maximum	Data type
Bet_Start_Datetime	1	1	dateTimeUTC ⁴⁵

Bet start date time is the combination of date and time when the player has placed the bet.

Bet_Cancellation_Reason

Field name	Minimum	Maximum	Data type
Bet_Cancellation_Reason	0	1	stringLong ⁴⁶

Bet cancellation reason is a description of the reason why a bet, for which the player already paid the stake, has been cancelled. In case there are many bet parts, and multiple cancellation reasons exist, the description "Different bet parts were cancelled" can be used.

Added for clarification

Bet_Type

Field name	Minimum	Maximum	Data type
Bet_Type	1	1	Enumeration

Bet type is an indication of the type of bet. For this field, options are:

- SINGLE: a bet is placed on one single sports event;
- COMBINED: a bet is placed on a combination of sports events, for every match one or more predictions are made and a player only wins if all predictions are correct;

⁴⁴ See [UID](#)

⁴⁵ See [dateTimeUTC](#)

⁴⁶ See [stringLong](#)

- XY: a bet is placed on a combination of Y sports events and a player wins if X out of Y predictions are correct;
- OTHER.

It is possible that the regulator will add other options in the future.

Bet_XY

Field name	Minimum	Maximum	Data type
Bet_XY	0	1	Int

Added for clarification

A bet X/Y is the number of results which should be correctly predicted in case of a bet of type XY. (see [Bet_Type](#)). This field is **mandatory** in case the Bet_Type is “XY”.

Bet_Commission

Field name	Minimum	Maximum	Data type
Bet_Commission	0	1	monetaryAmount

Bet commission is the total amount of commission that has been withheld from this bet by the operator. This field is optional, for bets where no commission is withheld, it does not have to be included.

Bet_Status

Field name	Minimum	Maximum	Data type
Bet_Status	1	1	Enumeration

Bet status represents the status of the bet reported.

For now the options are:

- BET_PLACED: a bet has been placed and accepted;
- BET_UPDATED: a prior placed bet has been ‘updated’ due to for instance cancellation of only a number but not all bet parts, or for instance due to a partial pay out;
- BET_SETTLED: A bet has been settled;
- BET_CANCELLED: a bet is cancelled due to one of many reasons;
- OTHER: all other statuses that do not fit any of the above.

Added due to new insights

It is possible that the regulator will add other options in the future.

Bet_Parts

Field name	Minimum	Maximum	Data type
Bet_Parts	1	1	n/a

The parent element bet_parts is a required root element which groups all bet parts belonging to a specific bet.

Part

Field name	Minimum	Maximum	Data type
Part	1	64	n/a

The parent element Part is a specific part of a bet. There must be a part for every prediction that is made within one bet.

Part_ID

Field name	Minimum	Maximum	Data type
Part_ID	1	1	UID ⁴⁷

Part is a unique identification of a part of a bet and must be unique within the data of a bet. I.e. one bet may not have two parts with the same part ID.

Part_Event

Field name	Minimum	Maximum	Data type
Part_Event	1	1	stringMedium ⁴⁸

Part event is the description of the sports event that is being bet on.

Part_Odds

Field name	Minimum	Maximum	Data type
Part_Odds	0	1	Decimal

Part odds shows the odds/quotation of the bet. This field is **mandatory**. Only in cases where there are no odds (e.g. pool betting), it does not need to be included. Fractional odds, such as 1/3 can be converted to a decimal number rounded to the 2nd decimal point.

Added for clarification

Part_Sport

Field name	Minimum	Maximum	Data type
Part_Sport	1	1	stringShort ⁴⁹

Part sport is an indication of the sport that is being practiced during the betting match. For now the types of sports can be reported, similar to how a provider categorizes bets for its customers (i.e. on their website). Such as for example football, badminton, darts and baseball. The Other option can be used for 'rare' sports if it is also offered on the website under the "Other" option. No underscores should be used, just 'plain names'.

Added for clarification

⁴⁷ See [UID](#)

⁴⁸ See [stringMedium](#)

⁴⁹ See [stringShort](#)

Part_Live

Field name	Minimum	Maximum	Data type
Part_Live	1	1	Boolean

Part live is an indication whether the bet has been placed before or during the sports match.

Part_Bank

Field name	Minimum	Maximum	Data type
Part_Bank	0	1	Boolean

Part bank is an indication whether this bet is a “bank tip” or not.

If a player is strongly convinced of the correctness of a prediction, some operators provide the possibility to mark the prediction as a bank tip/banker. This field is optional, as the banker option is generally only available for system bets.

Part_Match_Datetime

Field name	Minimum	Maximum	Data type
Part_Match_Datetime	1	1	dateTimeUTC ⁵⁰

Part match date time is the combination of the date and time when the sports match related to the bet started. If the sports match has been rescheduled, the actual date and time the event took place need to be listed here.

Part_Prognosis_Result_Type

Field name	Minimum	Maximum	Data type
Part_Prognosis_Result_Type	1	1	Enumeration

Part prognosis result type is the type of uncertainty that was bet upon. Examples are the final outcome of the match or the score at halftime.

For now the options are:

- MATCH ODDS
- TOTAL GOALS
- OTHER

As it is not completely clear which bet types are allowed, this list will be updated on a later moment.

⁵⁰ See [dateTimeUTC](#)

Part_Prognosis_Value

Field name	Minimum	Maximum	Data type
Part_Prognosis_Value	1	1	stringMedium ⁵¹

Part prognosis value is the predicted result value of the bet part.

Part_Stake

Field name	Minimum	Maximum	Data type
Part_Stake	1	1	monetaryAmount ⁵²

Part stake is the amount in euros that the player has set on this prediction. Either the Part_stake fields or the field Total_Stake of the bet are filled with values (other than 0). In case of (different) bets per Part_Stake, the Part_Stakes are filled in and the Total_Stake is 0. If the amount is wagered on the Total_Bet, the Part_Stakes are 0 and the total is filled in.

Added for clarification

Part_Cancellation_Reason

Field name	Minimum	Maximum	Data type
Part_Cancellation_Reason	0	1	stringLong ⁵³

Part cancellation reason is a description of the reason why this part of the bet has been cancelled. If the bet was cancelled in its entirety, the reason why should be specified in the field Bet_Cancellation_Reason and this field does not need to be included.

Bet_Total_Stake

Field name	Minimum	Maximum	Data type
Bet_Total_Stake	1	1	monetaryAmount

Bet total stake is the total amount in euros that the player has set on this bet.

⁵¹ See [stringMedium](#)

⁵² See [monetaryAmount](#)

⁵³ See [stringLong](#)

Bet_Transactions

Field name	Minimum	Maximum	Data type
Bet_Transactions	1	unbounded	n/a

Bet_Transactions is a reference to a transaction to or from a player account that is related to this bet. When a bet is placed, there is a STAKE transaction. When completing or cancelling a bet, a second transaction is connected to the bet. However, when completing or cancelling, only that second transaction needs to be reported and not the STAKE transaction for a second time.

Added for clarification

Player_Profile_ID

See [Player_Profile_ID](#)

Transaction_ID

See [Transaction_ID](#)

14. WOK_Complaint

What?	Description
Field name	WOK_Complaint
Minimum	1
Maximum	No maximum
Data type	n/a
Trigger	1. The complaint is submitted 2. The complaint is closed
Frequency	1. Immediately after the complaint is submitted 2. Immediately after the complaint is closed

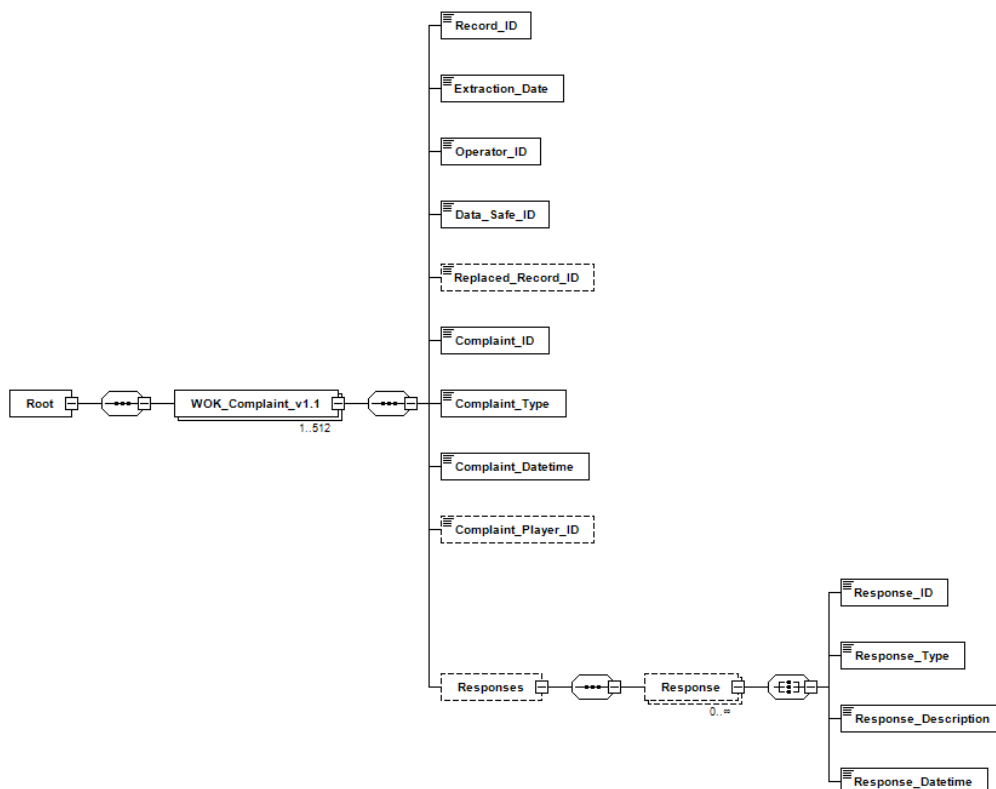

WOK_Complaint represents an incident (for example a complaint to the operator about an advertising campaign, a complaint to the Advertising Standards Association about a campaign, a complaint to the authorities about an advertising form or complaints about unfair game play). When a complaint is submitted we expect a complaint record without response information. When a complaint is closed we expect a new complaint record with the same complaint ID as the preceding record including the response information. Handling a complaint implies an response. The response_type field can be used to indicate what type of response the operator has applied. At this moment there is no limited list of response types to choose from. Please apply the response type that best suits the complaint handling business process. The complaint type is free format and only limited to the number of characters.

Added for clarification

Complaint_ID

Field name	Minimum	Maximum	Data type
Complaint_ID	1	1	UID ⁵⁴

Complaint ID is a unique identification of a complaint within the data of an operator. I.e. one operator may not have two complaints with the same ID.

Complaint_Type

Field name	Minimum	Maximum	Data type
Complaint_Type	1	1	stringMedium ⁵⁵

Complaint type is the type of incident which has occurred.

Complaint_Datetime

Field name	Minimum	Maximum	Data type
Complaint_Datetime	1	1	dateTimeUTC ⁵⁶

Complaint date time is the combination of the date and time when the incident occurred.

Complaint_Player_ID

Field name	Minimum	Maximum	Data type
Complaint_Player_ID	0	1	stringMedium

Data type is now in line with player profile id.

Complaint player ID is a reference to the player profile ID which was involved in the incident. This field is optional, if no people with a player account were involved, it does not have to be included.

Responses

Field name	Minimum	Maximum	Data type
Responses	1	1	n/a

Responses is a parent element for the operator's responses to complaints.

⁵⁴ See [UID](#)

⁵⁵ See [stringMedium](#)

⁵⁶ See [dateTimeUTC](#)

Response

Field name	Minimum	Maximum	Data type
Response	0	No maximum	n/a

Response is a response from the operator to an incident. This concerns the control of one part of the internal business processes: customer service (article 31h, first paragraph, gambling law).

Response_ID

Field name	Minimum	Maximum	Data type
Response_ID	1	1	UID ⁵⁷

Response ID is a unique identification of a response within the incident. I.e. one incident may not have two responses with the same ID.

Response_Type

Field name	Minimum	Maximum	Data type
Response_Type	1	1	stringMedium ⁵⁸

Response type is the type of response that the incident was followed up with (for example, intervention, follow-up, investigation).

The purpose of this field is to categorize a provider's response to a complaint. The provider can currently include a characterization that is appropriate in their business operations. As an example:

1. complaint is an opinion (Example: I think there is too much advertising), registration only;
2. complaint resolved - no omission found (example: fair game complaint);
3. complaint handled - complaint justified (example: payment remains pending);

At this time, an enumeration of possible types could not yet be given. As a result of 'lesson learned', this enumeration will be included in the data model in a future version.

Response_Description

Field name	Minimum	Maximum	Data type
Response_Description	1	1	stringLong ⁵⁹

Response description is the description of the final result of the incident follow-up.

⁵⁷ See [UID](#)

⁵⁸ See [stringMedium](#)

⁵⁹ See [stringLong](#)

Added for clarification

Response_Datetime

Field name	Minimum	Maximum	Data type
Response_Datetime	1	1	dateTimeUTC ⁶⁰

Response date time is the combination of the date and time when the response to the incident occurred.

⁶⁰ See [dateTimeUTC](#)

15. Custom data types used in the data formats

ksaType

This is a reference to the XSD onto which the cancellation is applied. The options are:

- wok_bet
- wok_complaint
- wok_game_session
- wok_game
- wok_intervention
- wok_operator
- wok_player_account_transaction
- wok_player_flags
- wok_player_limits
- wok_player_profile
- wwft_player_account_transaction

The usage of an WWFT safe and the wwft_player_account_transaction XSD has been discontinued on 25th April 2023 09:34 hours UTC.

dateTimeUTC

This data type indicates a date and time in the format yyyy-mm-ddThh:mm:ssZ, for example: 2016-02-27T10:24:15Z.

All timestamps in the XMLs are always in Coordinated Universal Time (UTC).

timeWindow

This data type is an enumeration to indicate how long a time interval lasts. For the time being the permitted values are:

- DAY;
- WEEK;
- MONTH;
- OTHER.

Other values may be added in the future if the regulator detects an excessive use of 'OTHER'.

monetaryAmount

This data type serves to record a sum of money and may be preceded by a '-' sign to indicate a negative amount. Two decimal places are required.

UID

This data type serves to record a unique ID of an entity. This is a series of characters built according to the pattern [8 characters] - [4 characters] - [4 characters] - [4 characters] - [12 characters], the permitted characters are lowercase a-z and number 0-9. The UID cannot be a consecutive number.

Int

The intended technical range is -2,147,483,647 to 2,147,483,647 which is the range of a regular integer also known as a 32 bit integer.

Boolean

Use true – false (instead of 1 – 0), in line with the canonical mapping according to the W3C XML schema standard.

Float

The Login_Duration field (Limit_Login in Wok_player_limits) must be filled in hours. The data type is a float to allow display in fractions of hours. It can support different time durations. For example: a player has set 93 minutes in this limit, then a Login_Duration value of 1.55 follows (93 minutes divided by 60 minutes).

stringShort

This data type is a series of characters of up to 32 characters.

stringMedium

This data type is a series of characters of up to 256 characters.

stringLong

This data type is a series of characters of a maximum of 1024 characters.



Afzendinggegevens

Kansspelautoriteit

Anna van Buerenplein 45A

2595 DA Den Haag

Postbus 298

2501 CG Den Haag

www.kansspelautoriteit.nl